



Formation And Safety Team (FAST) Formation Maneuvers Guide

The FAST Maneuvers Guide is published by FAST Intercontinental as a reference for member or applicant signatories. In conjunction with the practical test guides, these documents provide guidance in the development of an effective training and evaluation program for members of the FAST organization.

This is not a training manual. Please see your member signatory for all training material related to the maneuvers shown here. Absolutely no liability is implied with the publication of this document.

This publication will not be altered, edited or changed without the explicit written approval of the FAST Intercontinental organization. The Maneuvers Guide is for reference only. Copyright©2007 All Rights Reserved.

FAST Formation Maneuvers:

- 1. Parade**
- 2. Vic**
- 3. Finger Four**
- 4. Cross-under**
- 5. Close Trail**
- 6. Diamond**
- 7. Echelon**
- 8. Route**
- 9. Rendezvous**
- 10. Under run** (*sometimes termed "overshoot"*)
- 11. Lead change**
- 12. Takeoff**
 - a. Element Takeoff
 - b. Single-ship, Interval Takeoff
- 13. Recovery and Landing**
 - a. Overhead Pattern/Interval Landing
 - b. Element (formation) Landing
- 14. Mass Formation**

1. Parade (also referred to as “fingertip”)

Position:

Wingman positioned on bearing line with some vertical step down from the lead aircraft and minimum of 36 inches of lateral wingtip clearance. Vertical step down and bearing-line angle will be determined by signatory/aircraft type. Large bomber/transport aircraft (B-25 and larger) will fly no closer than 25 feet lateral wingtip clearance. Medium bomber/transport aircraft (Beech 18 and similar-sized) will fly no closer than 10 feet lateral wingtip clearance.

Maneuver:

All turns, climbs and descents. FAST qualification criteria: up to 45 degrees angle of bank (AOB), up to +/- 20 degrees of pitch.

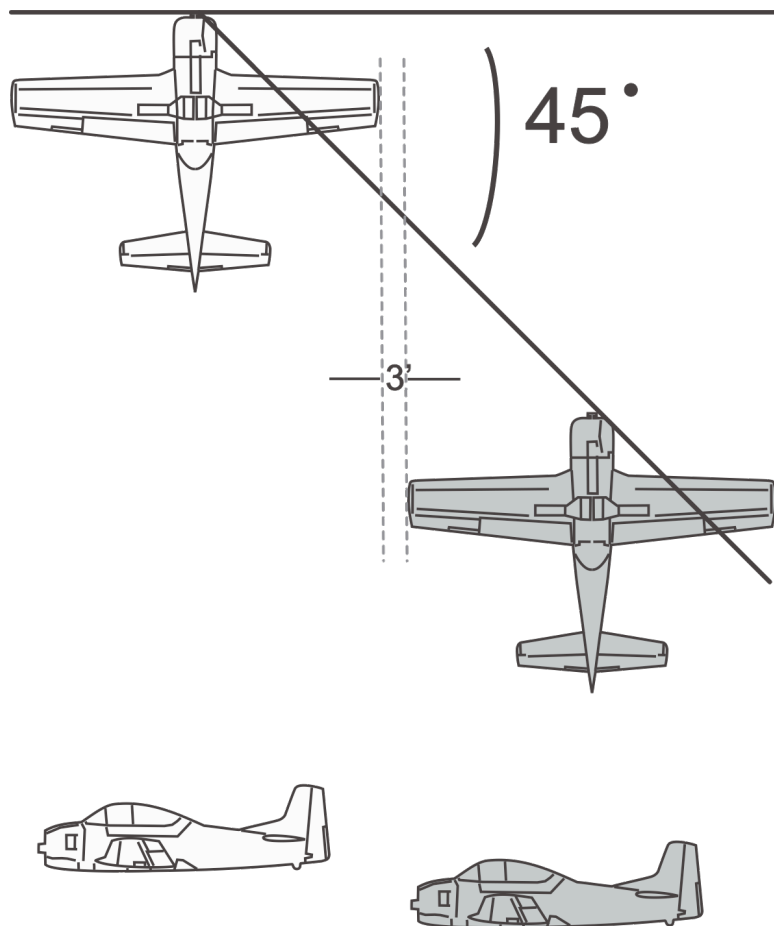

2. Vic

Position:

Wingmen positioned either side of the lead aircraft, on bearing line with some vertical step down from the lead aircraft and minimum of 36 inches of lateral wingtip clearance. Vertical step down and bearing line angle will be determined by signatory/aircraft type.

Maneuver:

All turns, climbs and descents. FAST qualification criteria: up to 45 degrees AOB, up to +/- 20 degrees of pitch.

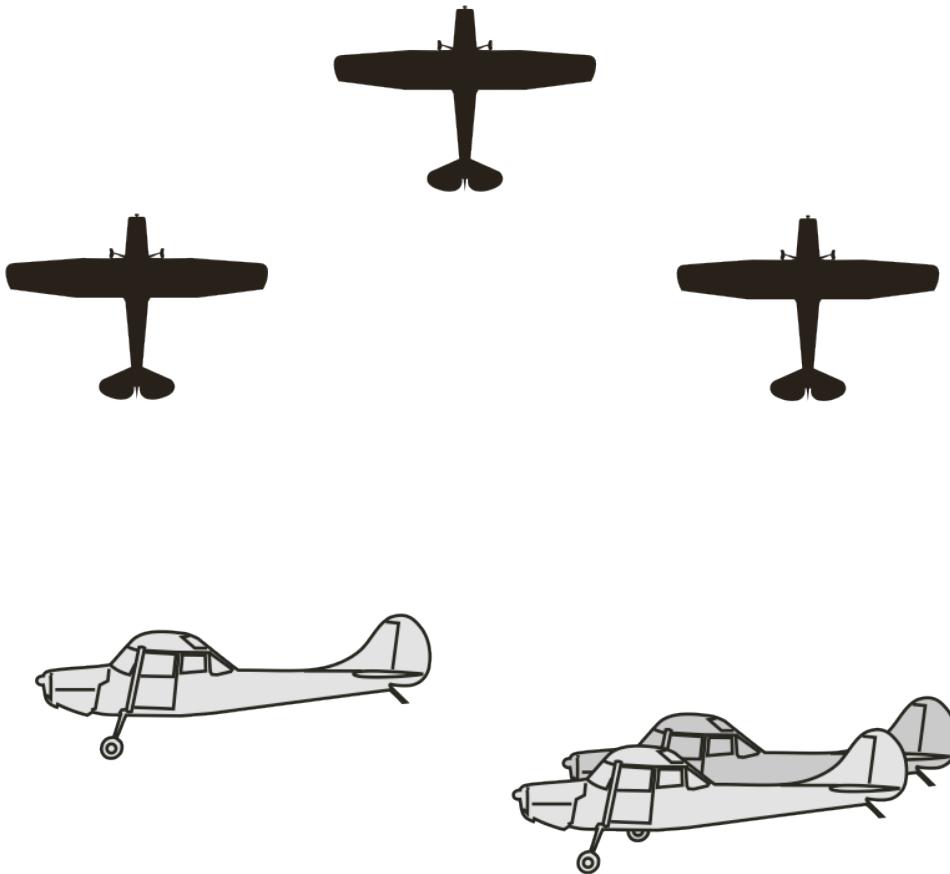

3. Finger Four

Position:

Two elements of two aircraft (leader and wingman) combined to make a four-ship formation. Consists of a wingman positioned on one side of the lead aircraft and a two-ship element positioned on the opposite side (strong right depicted), on bearing line with some vertical step down between aircraft and minimum of 36 inches of lateral wingtip clearance. Vertical step down and bearing line angle will be determined by signatory/aircraft type.

Maneuver:

All turns, climbs and descents. FAST qualification criteria: up to 45 degrees AOB, up to +/- 20 of pitch.

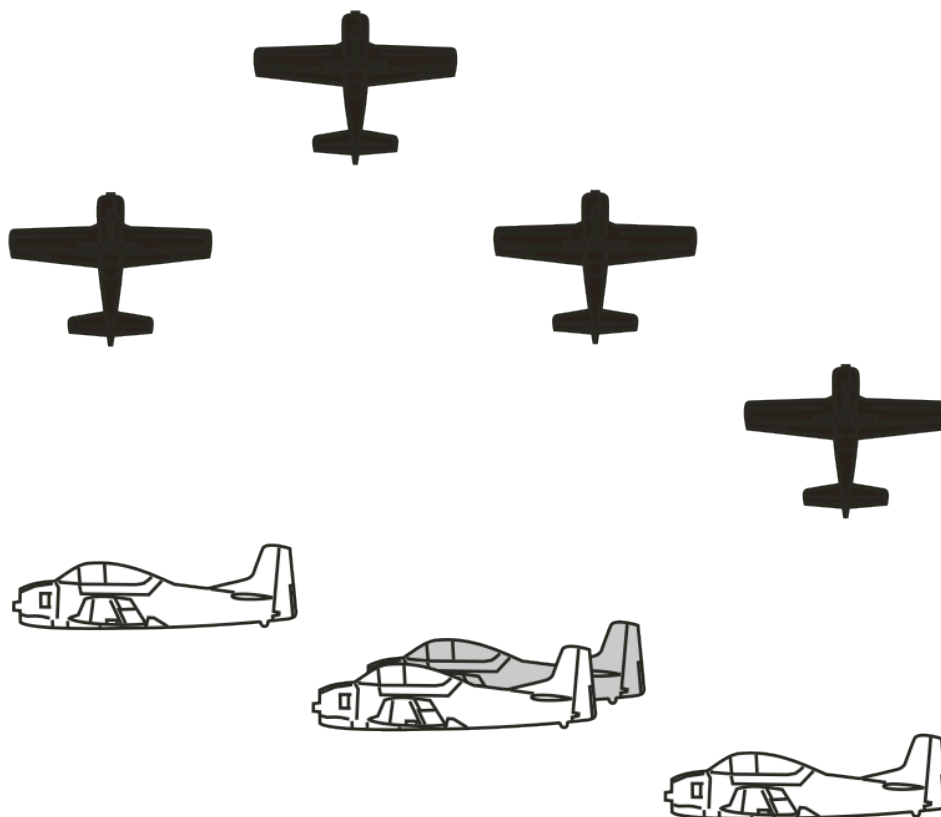

4. Cross-under

Maneuver:

Move one or more wingmen from one side of Lead to the opposite side.

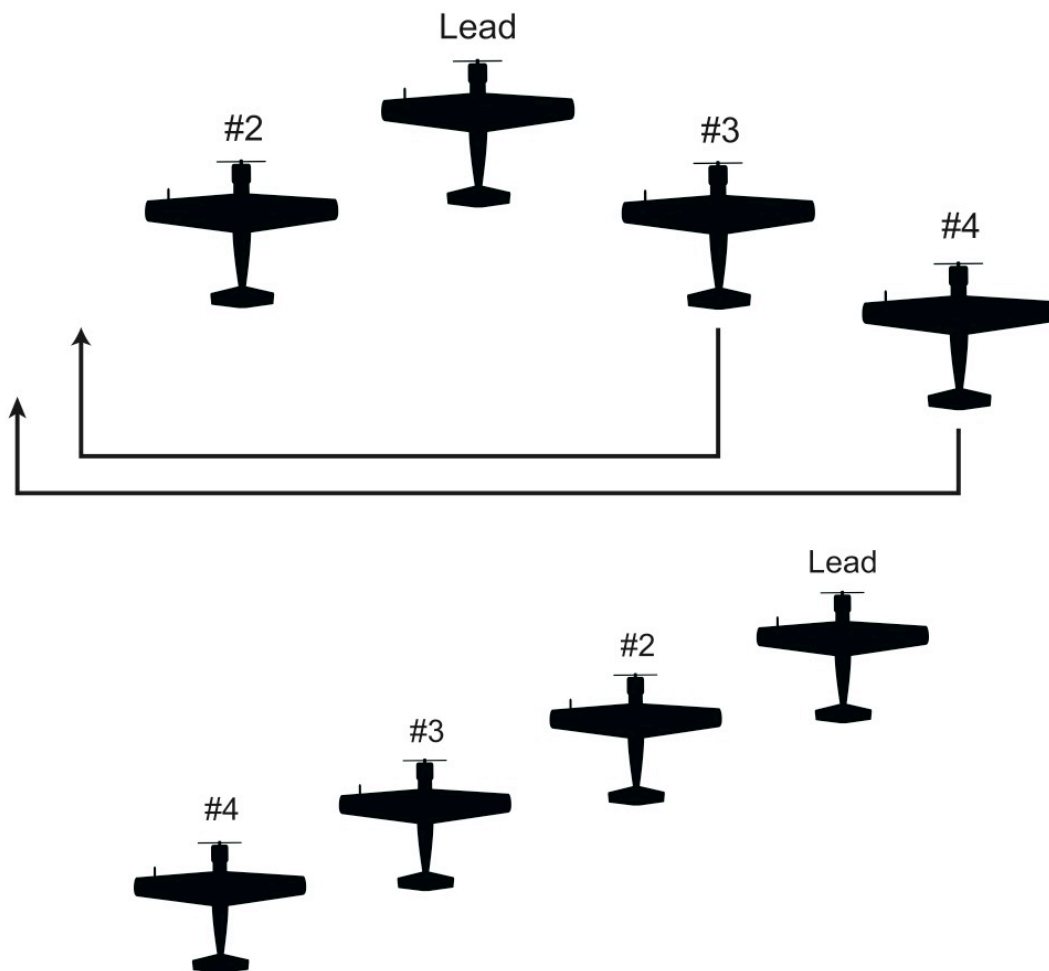

5. Close Trail

Position:

Up to four wingmen positioned in-trail of lead/one another with approximately one ship-length of spacing and some vertical step down. Vertical step down and in-trail spacing will be determined by signatory/aircraft type.

Maneuver:

All turns, climbs and descents. FAST qualification criteria: up to 45 degrees AOB, up to +/- 20 degrees of pitch.

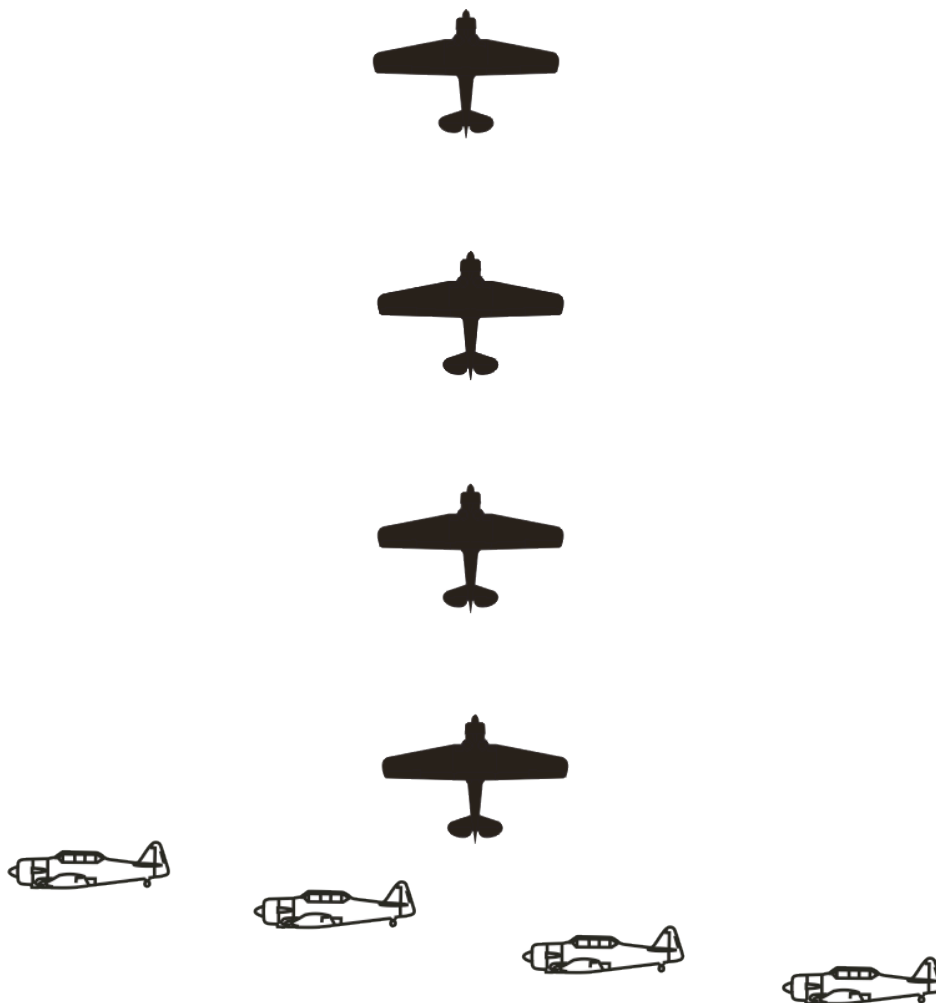

6. Diamond

Position:

Two wingmen on the bearing line, positioned either side of the lead, and one (#4) wingman in trail. Wingmen maintain some vertical step down between aircraft and minimum of 36 inches of lateral wingtip clearance. Vertical step down and bearing line angle will be determined by signatory/aircraft type.

Maneuver:

All turns, climbs and descents. FAST qualification criteria: up to 45 degrees AOB, up to +/- 20 degrees of pitch.

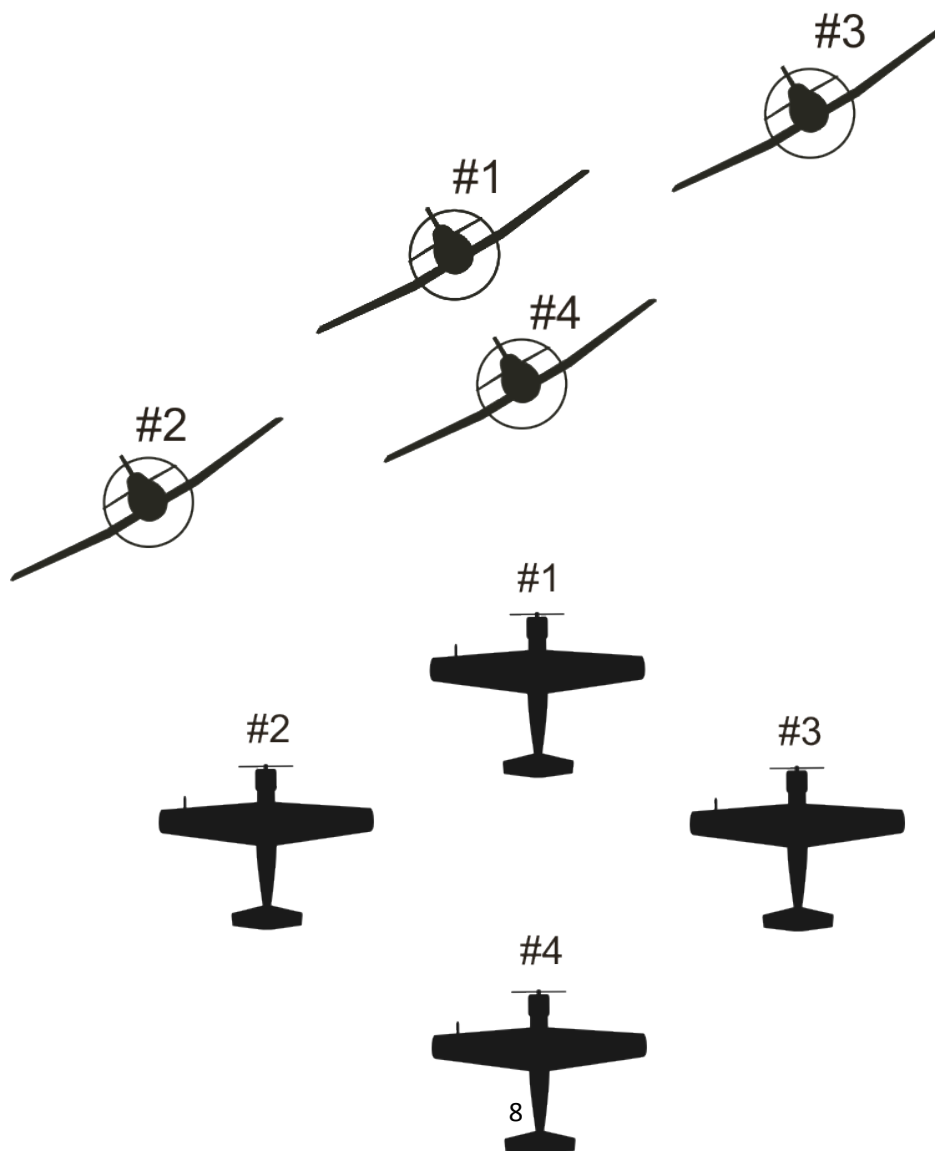

7. Echelon

Position:

Up to three wingmen on the bearing line, all positioned on one side or the other of the lead aircraft (echelon right depicted). Wingmen maintain some vertical step down between aircraft. Vertical step down and bearing line angle will be determined by signatory/aircraft type.

Maneuver:

All turns are executed away from the wingmen. All turns, climbs and descents. FAST qualification criteria: up to 45 degrees AOB, up to +/- 20 degrees of pitch.

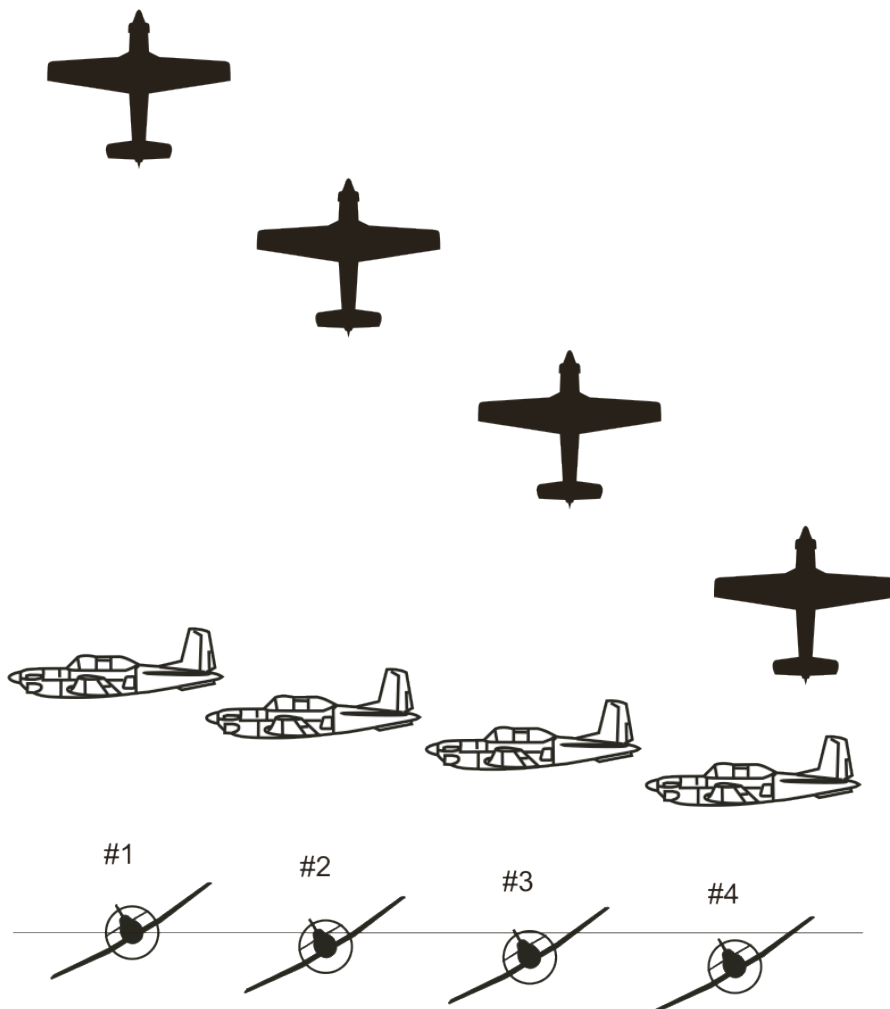

8. Route

A) Description

A flexible formation position identical to parade or finger four (based on number of aircraft) with the distance between aircraft limited to a range of from 2 ship-widths to 500 feet.

B) Procedures

Route will be called for by the flight lead for all radio frequency changes, checklists and other times, as needed. Wingmen will attempt to maintain the bearing line while moving out to the prescribed interval. During maneuvering (turning), wingmen on the outside of the turn will maneuver in echelon using in-plane references. Wingmen on the inside of the turn will descend only as needed to keep the flight lead in sight.

9. Rendezvous

A) Description/Procedures

Rendezvous should be conducted with the rejoining wingman's aircraft slightly stepped down (vertical separation determined by signatory) until established in formation route position with minimal and controllable closure. Controllable closure described as little or no heading crossing angle (fuselages aligned) and nearly matched airspeeds.

If rejoining more than one aircraft in sequence, such as during four-ship maneuvers, each aircraft will maintain a minimum of 100 feet from preceding aircraft until that aircraft is stabilized in route or parade position. See also: wingman and flight leader practical test guides.

10. Under run *(sometimes termed “overshoot”)*

A) Description

The ability for one aircraft (wingman) to safely maneuver away from all other aircraft during a botched formation rejoin.

B) Procedures

During the rejoin, whether straight and level or turning, if closure is excessive, the wingman will not rejoin to parade position, but will under run (pass behind and below for a turning rejoin or slide forward for a straight ahead rejoin) in such a manner as to ensure at no time a potential for collision exists between any and all aircraft in the formation.

11. Lead Change

A) Description

The procedures to safely identify and transition to a new flight leader

B) Procedures

All lead change procedures will be conducted from the route formation position (2 to 4 ship-widths between aircraft), see page 15. Reference FAST Communication Standards for applicable radio and hand signal procedures.

12. Takeoff

A) Runway Requirements

Description: Formation operations that necessitate two or more aircraft in simultaneous movement on a runway for takeoff require the following runway dimensions:

The runway's total width must allow for both aircraft to maintain a minimum of ten feet lateral wingtip clearance between them at all times. Both aircraft must be fully on the prepared surface of the runway in making this determination.

In the case of element takeoffs, the runway length should be no less than a minimum of 20% greater than the normal calculated takeoff roll for all aircraft provided by their Pilot Operating Handbook/Operating Specifications.

B) Element Takeoff

Description: An element of two aircraft aligned on the runway with the second aircraft on a selected bearing line with a minimum of ten feet lateral wingtip spacing. The element pilots initiate brake release and takeoff roll simultaneously and maintain the same relative position throughout rotation and lift off. Gear and flap retraction will be accomplished in unison. In the case of multiple elements or flights departing the same runway, flights containing tailwheel aircraft will not commence the takeoff roll until the preceding aircraft/element has reached rotation and lift off is confirmed—this is because of the inherent visibility restrictions with the tailwheel configuration. Element takeoffs are not authorized for bomber/transport aircraft.

C) Staggered Interval Takeoff

Description: An element of two or more aircraft that will depart individually, and rejoin after takeoff. Because of the restricted forward visibility inherent in tailwheel aircraft, tailwheel pilots will hold position until the aircraft ahead has rotated and lift off is confirmed before commencing the takeoff roll.

13. Recovery and Landing

A) Runway Requirements

Description: Formation operations that necessitate two or more aircraft in simultaneous movement on a runway for landing/roll out require the following runway dimensions: the runway's total width must allow for both aircraft to maintain a minimum of ten feet wingtip clearance with both aircraft on the prepared surface.

B) Overhead Pattern and Landing Procedures

Description: A landing pattern conducted under VFR conditions to recover multiple formation aircraft efficiently. The formation is aligned in echelon such that all required pattern turns will be away from the wingmen. The formation is then maneuvered to an upwind position approaching the landing runway in level flight ("initial"). Altitude is normally equal to or greater than the airfield published pattern altitude, but will be determined by the flight lead.

At a point selected by the flight lead (number 1), normally near the approach end of the landing runway, he/she will perform a level turn away from the flight using up to 60 degrees of bank and continue the turn approximately 180 degrees to an inside downwind leg while reducing to downwind airspeed as required by aircraft specifications/POH. Number 1 will then configure his/her aircraft for landing and begin a descending turn to final. Each formation aircraft will follow suit, beginning the turn to inside downwind at an interval specified by number 1, or each pilot will use five seconds between aircraft if no interval is provided.

B.1) Single-Ship, Interval Landings

If the runway width and conditions allow landing on either side of the runway with a minimum of ten feet wingtip separation, each aircraft will land on opposite sides from one another with the lead aircraft normally landing on the side of intended runway exit. Each subsequent aircraft will cross the landing threshold with no less than the minimum prescribed interval published for that type aircraft. For most warbirds with approach speeds under 100 knots, 1500 feet is the recommended minimum distance between aircraft crossing the threshold. For aircraft with approach speeds in excess of 100 knots, 3000 feet is the minimum recommended interval between aircraft crossing the threshold. Regardless of approach speed, all aircraft must be capable of maintaining sight of the preceding aircraft during approach, landing and rollout.

When landing more than two aircraft using staggered procedures, each pilot landing on the side of intended runway exit will verbally clear the preceding wingman to cross to their side (runway exit side) when they determine it is safe to do so. Staggered, interval landings are not authorized for bomber/transport aircraft.

B.2) Hot-Cold Interval Landings

This is an alternative to staggered landing procedures and requires the same runway width criteria as outlined in paragraph B.1. The lead aircraft will land on the side of the runway of intended ramp exit, thus designating the "cold" side of the runway.

All subsequent aircraft will land on the opposite side ("hot" side) or favor the hot side of centerline. Upon touchdown and when safe to do so, without unnecessary delay, each wingman will move to the cold side to complete landing roll out and runway exit, thus providing a clear, hot lane for following aircraft to land. Minimum interval is as prescribed in B.1 or as

determined by signatory, but should be great enough to provide a clear lane on the hot side for landing aircraft and ensure visual contact with preceding aircraft can be maintained at all time during approach, landing and rollout. Hot-cold, interval landings are not authorized for bomber/transport aircraft.

C) Element Approach and Landing

Description: A formation approach conducted with two aircraft in a modified parade formation position. Modified parade position requires a minimum of ten feet of lateral wingtip clearance and number 2 near level with number 1 and configured, during final approach and touchdown. Aircraft will land together (wingman should touchdown first or simultaneously with Lead) on their respective sides of the runway. Element approach and landings are not authorized for bomber/transport aircraft.

Signatories will provide applicable procedural and training guidance for the element landing and potential go-around.

14. Mass Formation

The term “mass formation” reflects any formation of more than four aircraft and may be comprised of one or several of the formations contained in the FAST Maneuvers Guide. Signatories will maintain applicable guidance on training and evaluation of mass formation activity.

See supporting graphics on following pages.

Image: Lead Change Options

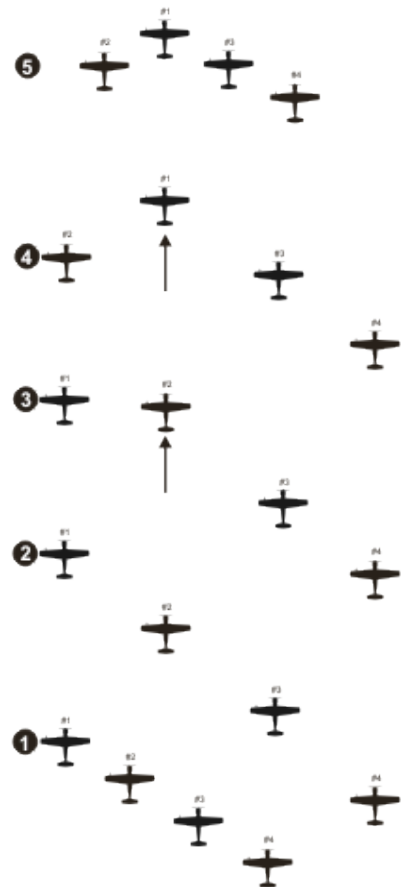
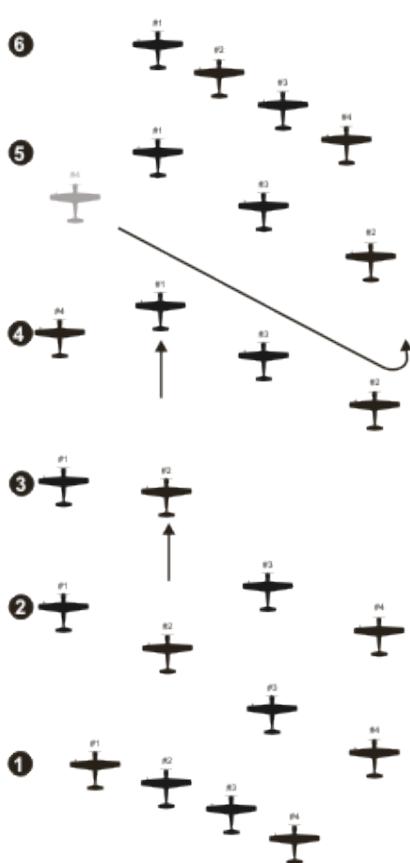
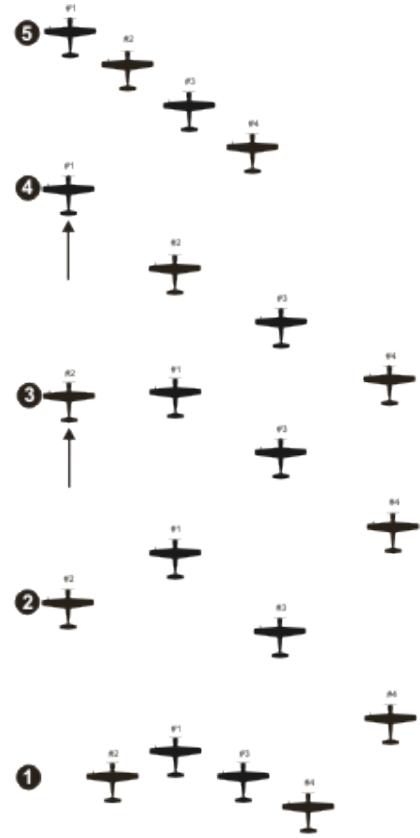
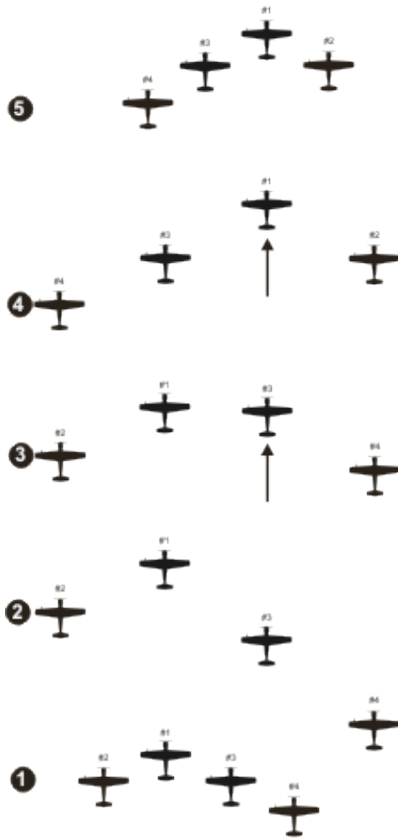

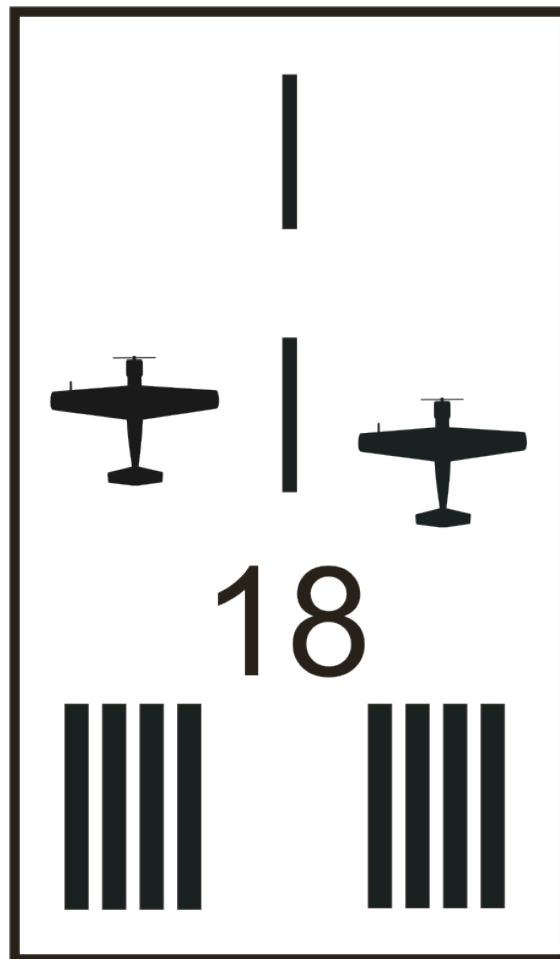

Image: Runway Width Criteria

Runway width criteria for landing or takeoff require a minimum of 10 feet of lateral wingtip clearance while aircraft are in motion regardless of procedure used (element or interval takeoff/landing)

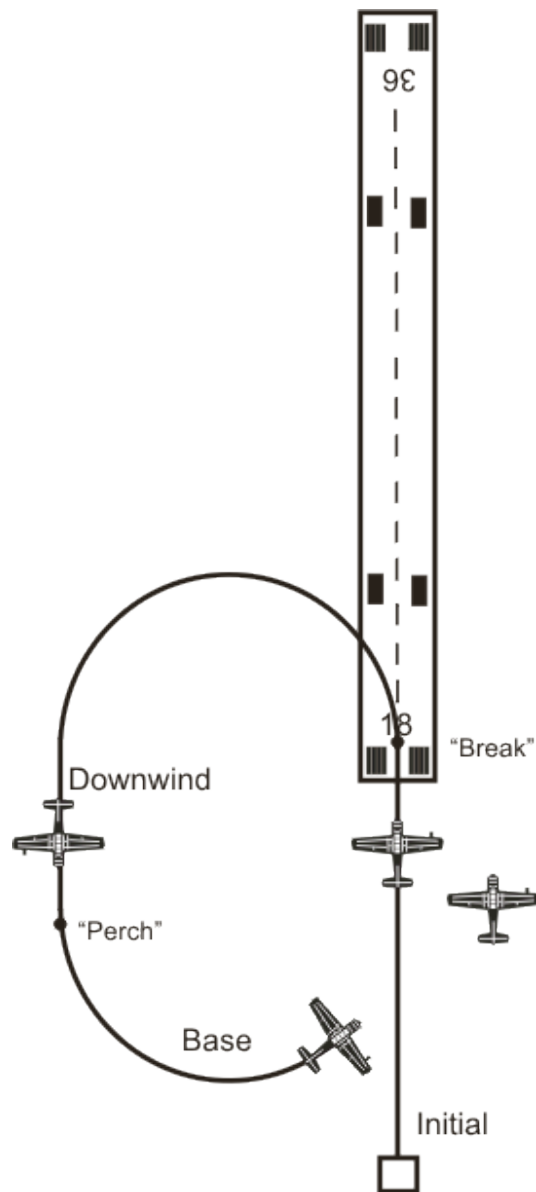

Image: Overhead Pattern

The “overhead” pattern provides for rapid recovery of formation aircraft. While the flight lead may choose any “break” interval (time between individual aircraft maneuvering to the downwind leg), all aircraft must establish a minimum safe distance between aircraft crossing the threshold for landing. See page 12.

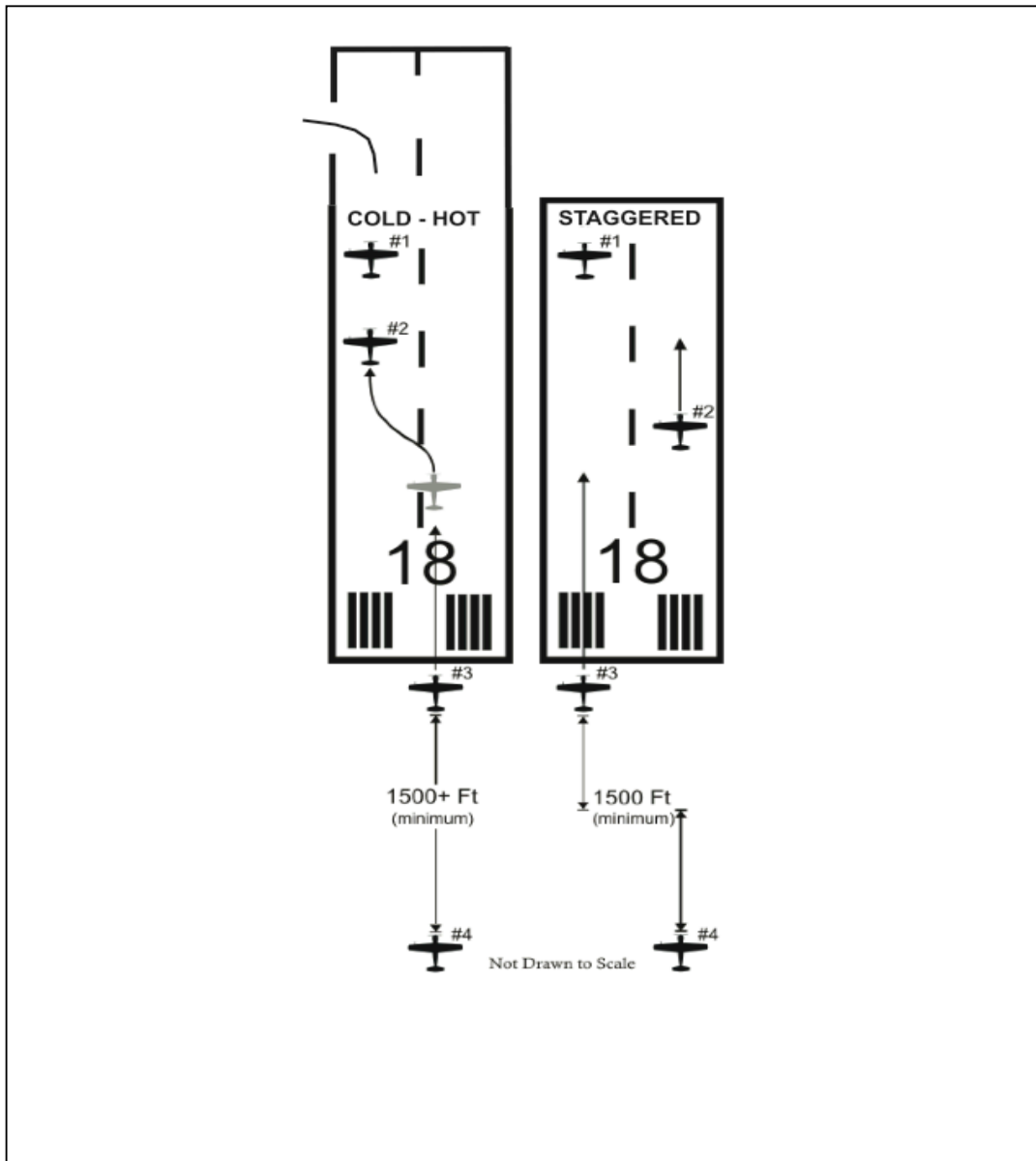

Image: Interval Landing Options

Interval landing options (“hot-cold” or “staggered”) as show here should provide for a minimum safe distance between aircraft providing constant visual contact between aircraft during approach, landing and roll out (not authorized for bomber/transport aircraft). These procedures mitigate the potential for aircraft collision or forced runway departure should a pilot experience a mechanical failure or other emergency. Distances provided above are examples only—signatories will publish recommended minimum safe intervals for their type aircraft.

FAST Intercontinental policy on training

(Reference: *FAST Foundation and Principals*)

Signatories will maintain applicable training guidance for their specific aircraft in all aspects of normal and abnormal formation procedures applicable to the maneuvers contained here and included in the practical test guides for wingman and flight leader. Signatory guidance must include as a minimum, but is not limited to:

1. Guidance for aircraft movement on the ground
2. All Formation departures and recoveries listed here
3. All FAST formation in-flight maneuvers listed here
4. Abnormal procedures applicable to all phases of flight
5. Formation radio communications and visual signals

When developing a signatory training program for the basic FAST qualification, members will reference all FAST Intercontinental Standardization Documents to include;

1. *FAST Formation Maneuvers Guide* (this document)
2. *FAST Radio Communication and Cockpit Visual Signals Guide*
3. FAST practical test guides (wingman and flight leader)
4. *FAST Foundation and Principals* (FF&P)



Direct all inquiries to: fast@flyfast.org